

Kevin West
Research & Development

New York London
Hong Kong Sydney
Beijing Moscow Cairo

Kevin@WaterforFuel.Com

WWW.WaterforFuel.Com

Water for Fuel, LLC
Imagine the possibilities



You may NOT redistribute, copy, or give away this copyrighted material unless you have written permission. Visit WWW.WaterforFuel.Com and purchase a CD or DVD with this document on it. The money goes to support this 100% water powered vehicle project. Please read through this a few times carefully before beginning your conversion.



Version 4.20 Written By Kevin West (Epicdude)

© Water for Fuel 2008

Rewire & Rewind your alternator like Water for Fuel.

I only use Delco Remy alternators because they are the easiest to rewire and perform the best in my test. I tested 6 others including some old alternators with external voltage regulators. They either worked poorly or not at all after being rewired. So make it easy on yourself and use a Delco Remy 10 SI alternator. The alternators are common on 1975-1985 Chevy/GMC vehicles. The electronics and alternator conversion takes me about a day to complete, but could take you 2 weeks if you aren't motivated. You can get a rewind kit from WWW.WaterforFuel.Com and save lots of time!

1st : Get your Delco Remy 10SI alternator: new (60\$) or used (20\$ from junk yard). If you buy from a junk yard make sure the alternator looks and sounds good, it should spin freely and not squeak. Remove the 4 bolts and take the pulley/fan/rotor out. Inspect the brushes and make sure the entire alternator is in over-all good condition. Remember: "Don't work with crap because crap don't work."



2nd : Remove all the nuts and bolts out of everything inside and take the stator out followed by the bridge rectifier, voltage regulator, fuse, and brush housing. Keep the brush housing.

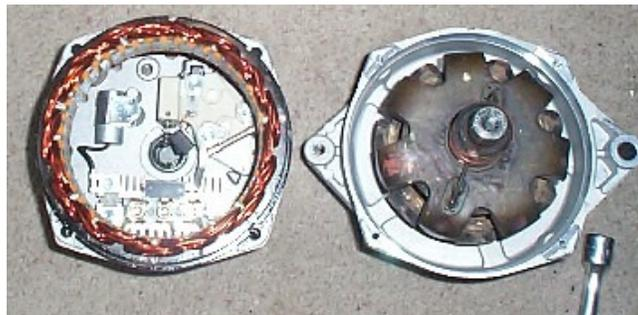

3rd : From inside the alternator you threw away the bridge rectifier, diode, and the voltage regulator, but you were careful to keep the brush housing and bolts. Get a PCB (perf board part # 276-148 from Radio Shack) and glue in your PC board over the vent holes. Drill some holes and attached your 3 Phase bridge rectifier (part #36MT160 from DigiKey.Com). Solder in a male spade connector for your neutral wires to connect to.

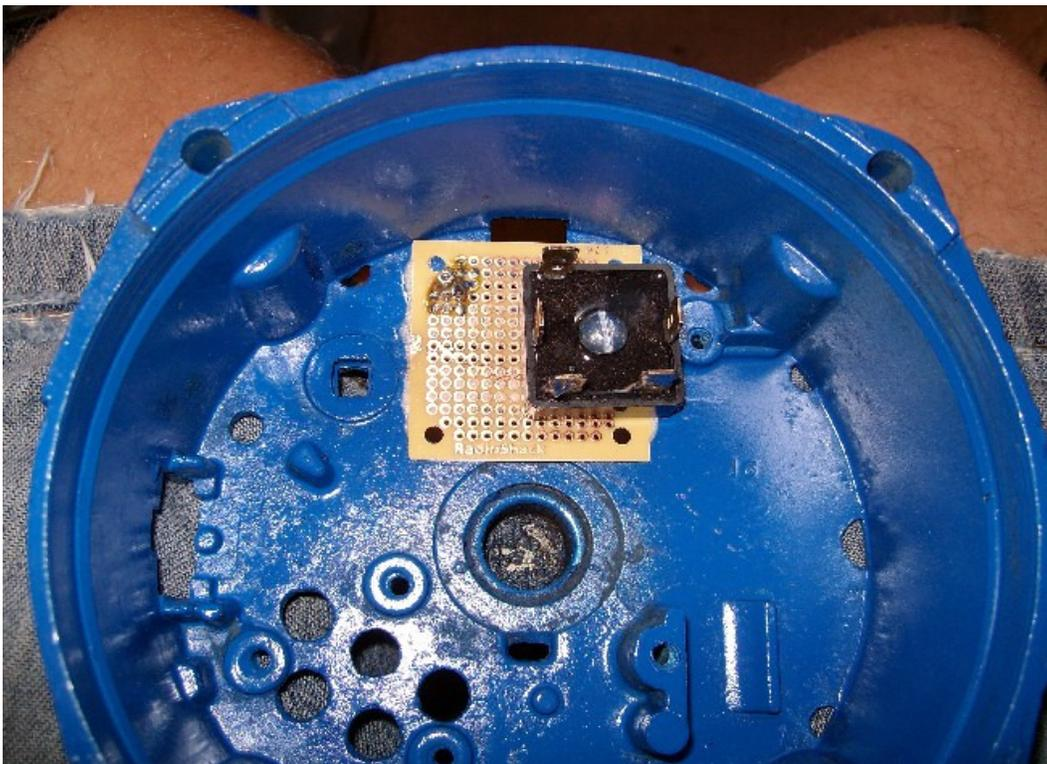
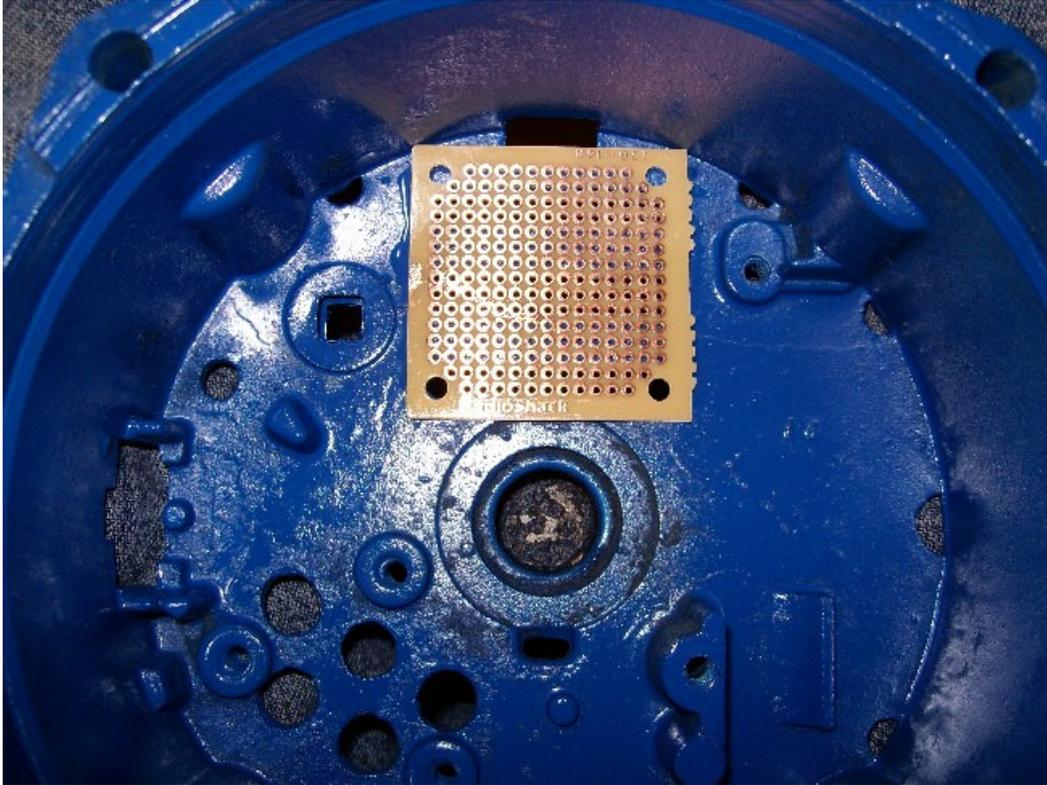

4th : You have to connect a red and black wire to the brushes directly. You will find 3 bolts holding the brush housing on. 2 of these bolts are directly connect to each brush: one will be positive and the other negative. The 2 bolts I speak of have a little piece of plastic on them, the 3rd bolt doesn't. Get some round eye connectors and connect a red positive wire and black negative wire to your brush housing using the bolts that have the plastic on them. It doesn't matter which is positive or negative. **MOST IMPORTANT OF ALL!!** You must insulate the brush housing from the alternator housing. This is done by placing three ¼ inch nylon washers **BETWEEN THE TWO HALVES** of the brush housing. Then reattach the brush housing to the alternator housing using the bolts. After doing so make sure you test your red and black wire for a dead short between the housing and each other. **THERE SHOULD BE NO CONNECTION BETWEEN THE ALTERNATOR HOUSING AND/OR YOUR RED AND BLACK WIRES.** The trick to holding the brushes in is to insert a paperclip through the back of the housing to hold the brushes in before reassembly. Test for dead shorts before inserting the paper clip or you'll read a dead short.



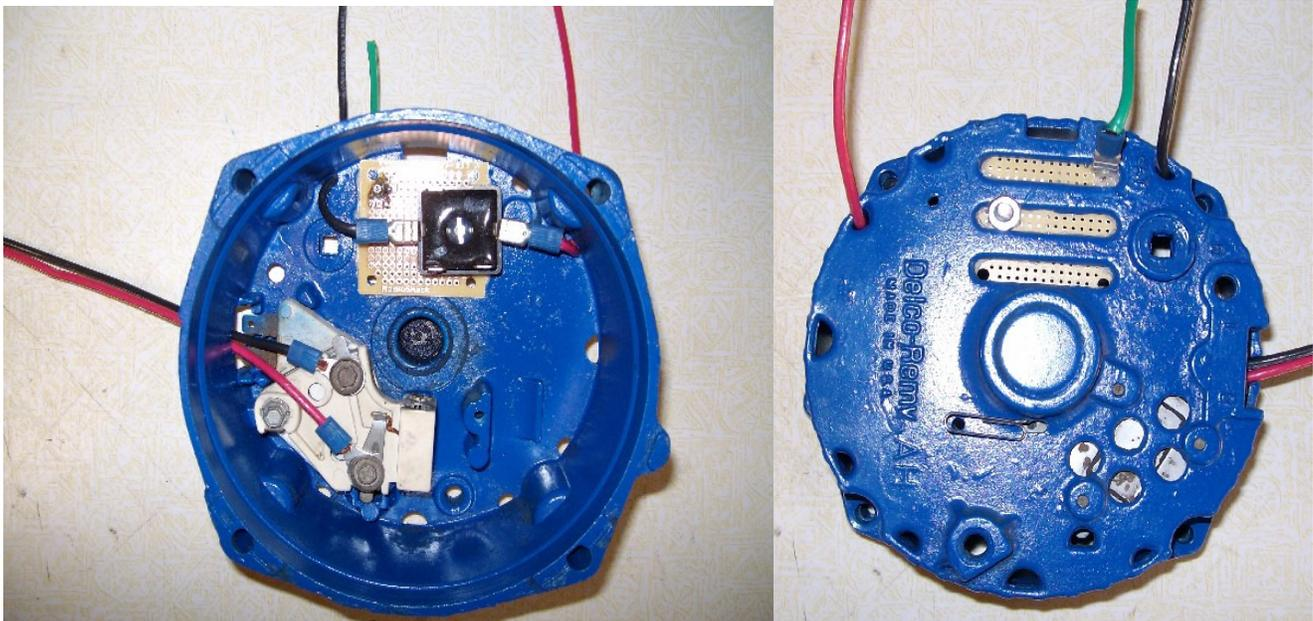

Note: Be sure your brushes are clean. If you contaminate them with some lubricant make sure to wipe them clean before putting them back in. Otherwise it won't make a good contact and the alternator will work poorly. Clean your rotor contacts too!

5th : Cut those coil loops off the stator with a hack saw, dikes, your teeth, band saw, sharp mind, or dremel tool. Pull the wires out with some vise grips. Be careful not to harm the paper backing or you will have to replace it (be sure not to cut your hand or head off too). If the paper is old and looks like crap go ahead and replace it. The paper isn't cheap and you can only get Nomex 410 (or any other electric motor dielectric paper) from some sort of alternator/motor repair shop. You'll need to go there anyways to get the Nomex 410 preformed cuff/sleeve paper which holds the wire in the slot wells on core of the stator. Take your stator and some cash when you visit them because you need paper, sleeves/cuffs, and 1 pound of 27AWG magnet wire. Below are stators with the wire removed, one with new white paper and the other with old paper/plastic. Glue the backing paper into the back of the stator after you paint it, but don't glue the cuffs/sleeves in. I paint my stators blue (company color) real good and glue in the Nomex.

NOTE: When I put the wire into the wire well the painted stator edges don't scrape the wires protective coating off.

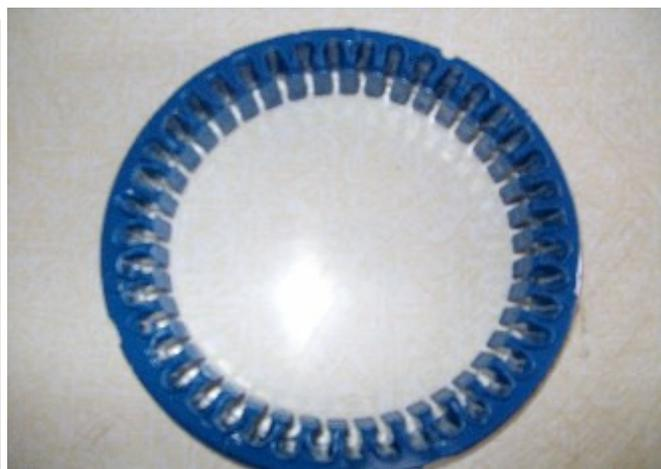

6th : Next I grab a piece of 1 ¼ inch PVC about 8 inches long to wrap the 27AWG wire around. I use small zip ties to hold everything together neatly. The trick to making alternator loops is to alternate your windings. The first loop will have 40 winds (42 winds to be exact) and be wound counter clockwise, and then the next loop is wound clockwise, then the next loop counter clockwise, and then it repeats. This is done 13 times for small alternators and more with larger alternators.

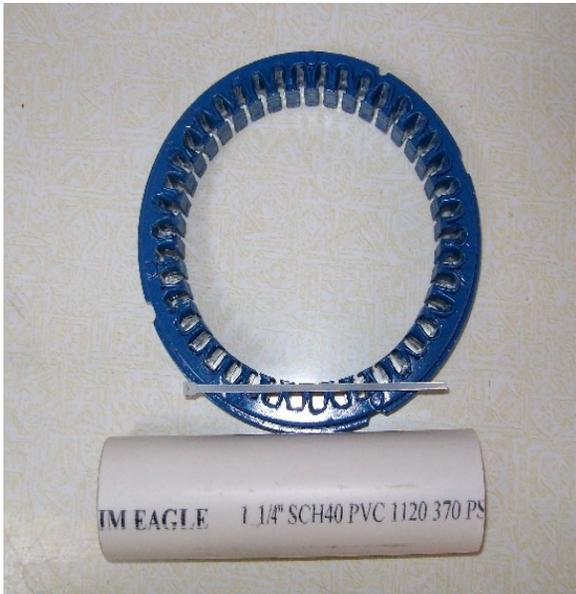

7th : Make sure you add one or two extra winds to each loop so you have room to play with when installing them. Try not to bend or kink the wire, but if you do and it doesn't break it should still work ok. I can't stress enough to count your winds (40 winds with a few extra) and to count your loops needed (usually 13 loops) before you cut the wire. Broken wires will need to be soldered back together or start over. After each loop zip tie it to the last and clip those tie tails off so they don't get in your way and aggravate you.

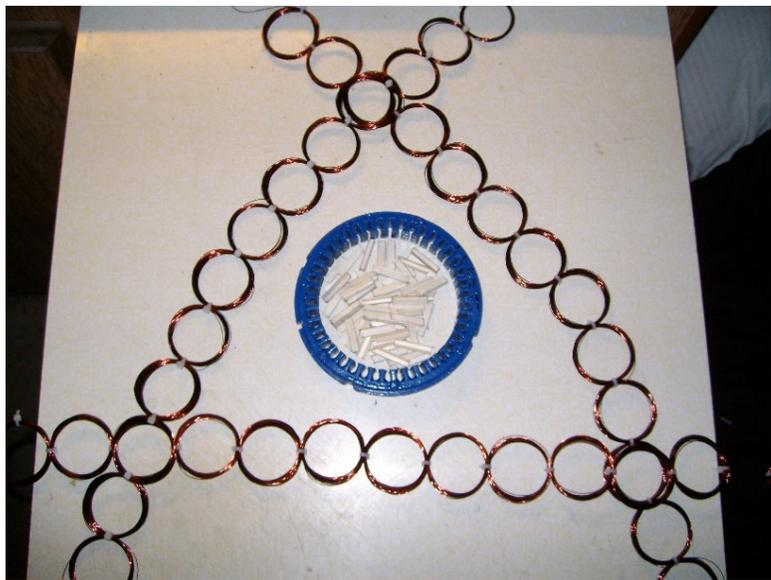

8th : You're almost finished. Make sure you have 3 phases exactly the same (13 loops with 40 winds each loop). Grab your torroid stator, line up the mounting holes, and mark line line line and wave wave wave (I I S S S) where you're going to run your wires to your rectifier (near the vent). This is usually around the dimple on the stator. This helps me know where to start and end my loops. If you have to replace your paper then cut your squares out to fit just under the lips in each wire well on the stator (approximately 1x 3/4 inch squares). The first loop's empty side will go in the first ~, then you skip two holes and put the "wired" side in.



9th : You MUST have 2 gaps in the middle of each loop like below. Do this all the way around the stator and clip those zip ties off VERY CAREFULLY! Slide your Nomex cuff in to hold everything nice and neat. I have seen many different winding techniques from opening up so many alternators. You almost can't screw this up yall. The connecting wire from coil to coil should always go into and come out of the same wire well. The wire loops should alternate like so: clean loop side in, wires in/out loop side in the same well, next clean loop side in, and then wires in/out in the same well.



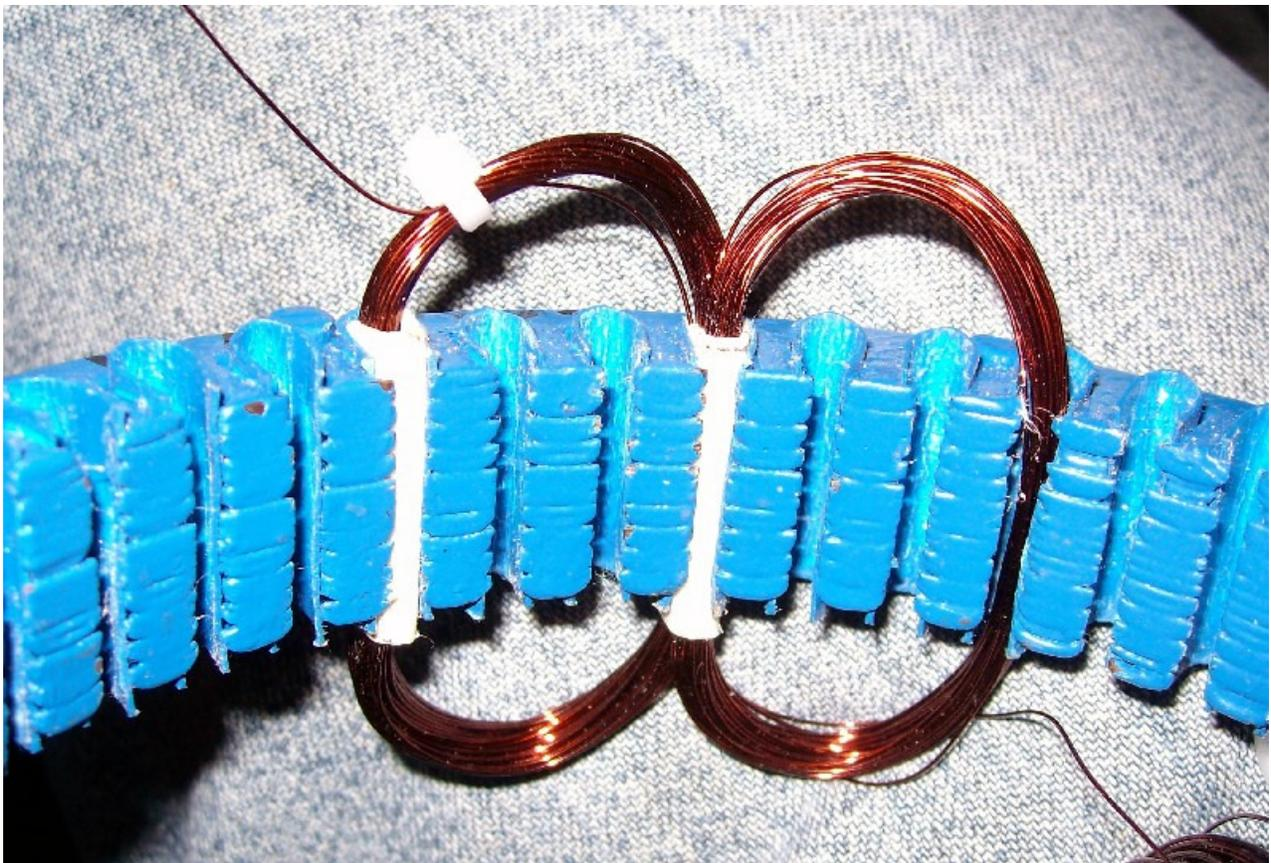
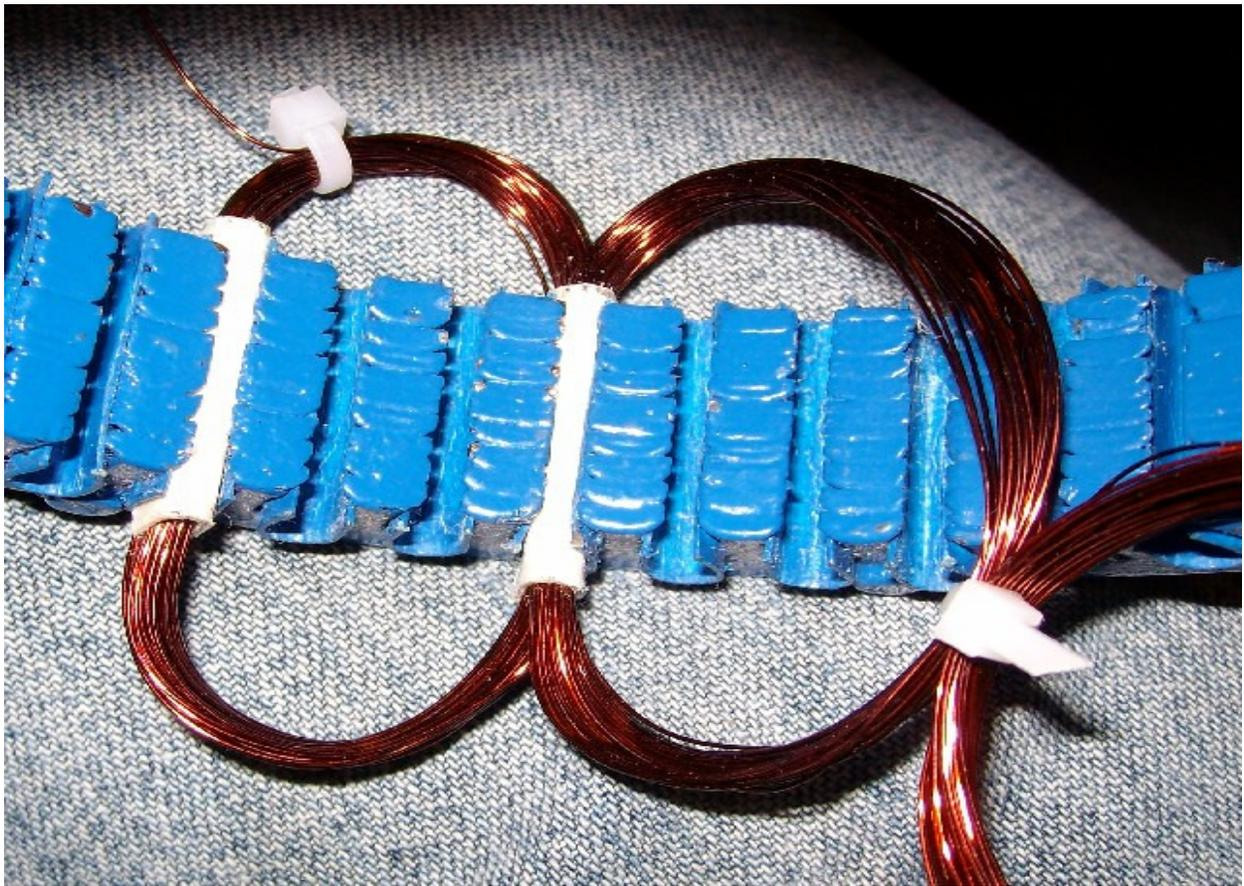

10th : You want to do this all the way around your stator until you end on one of the Lines you made on the stator opposite of the corresponding Wave (I S). When you start with a clean loop (first mark) you will end with a clean loop (last mark). Do this to each phase. You must double-stuff or your voltage will be low. The bottom of the stator should look like the top when you're finished. If it doesn't then go back and fix it. I spray lacquer and sometimes put some liquid electrical tape (Wal-Mart) on the loops of the stator so they hold together after I have completed the whole rewind and don't short out to the case. Don't cut the wires short until you have the PCB glued in and the bridge rectifier bolted on. Then you place the stator in to see how much wire you need to solder everything up. I cut the excess off, solder everything up, and then cut off any extra wire left.

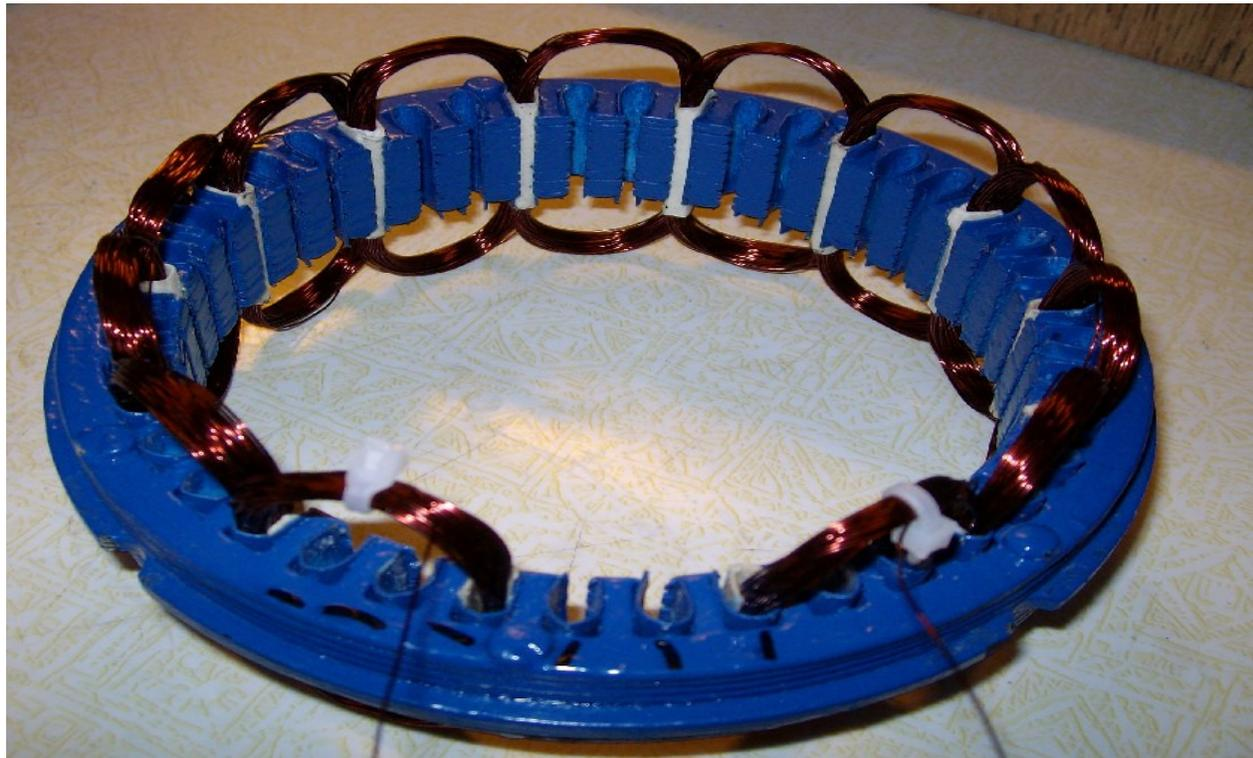
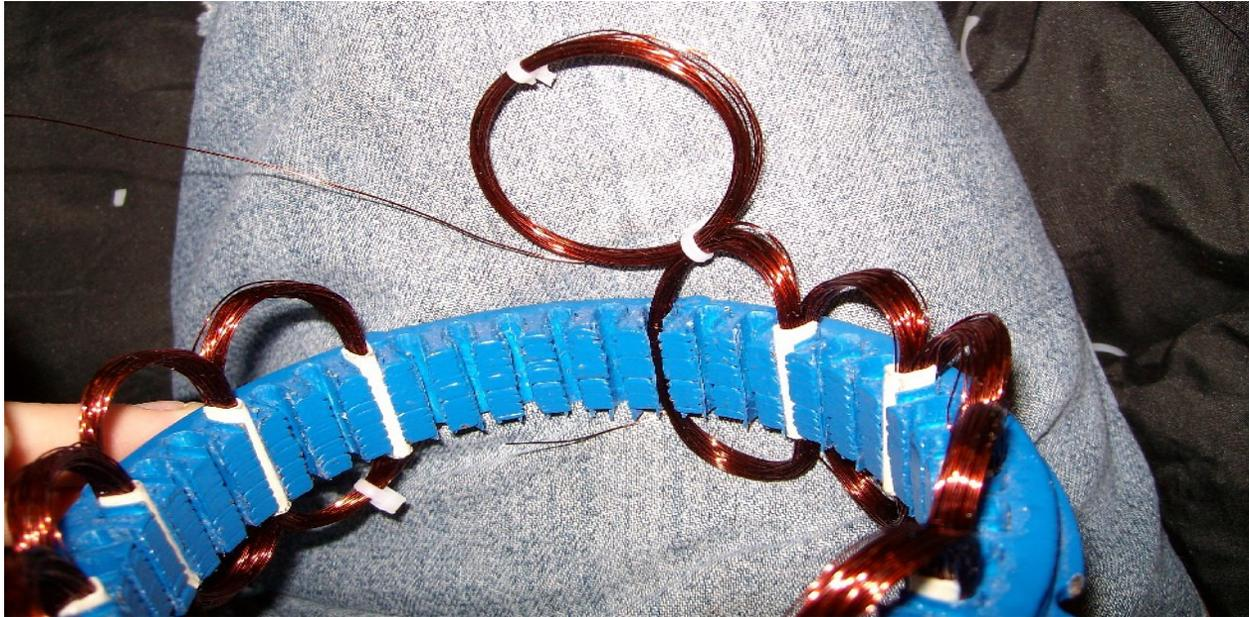

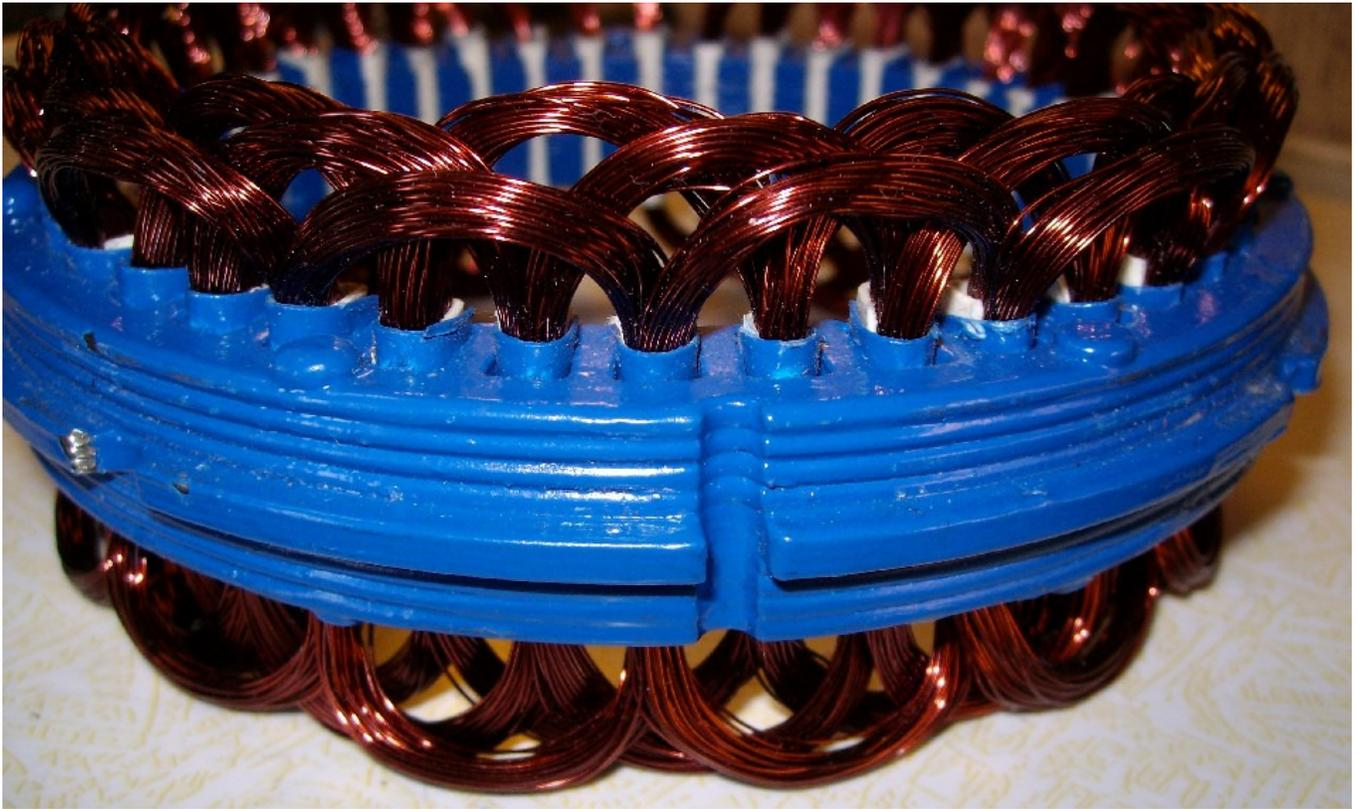
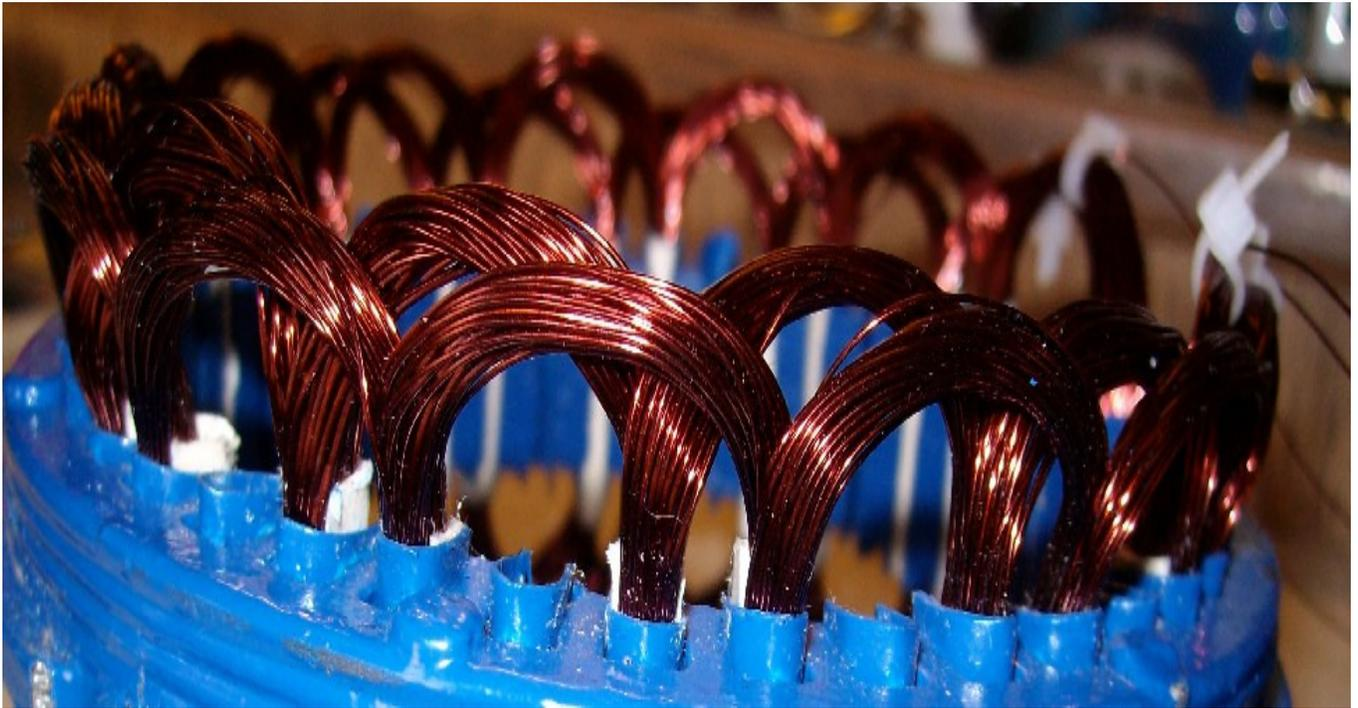

11th : The directions should be clear as to where to put the AC and where the DC comes out. If anyone wants to know which wire is AC and which is Neutral? They all are. But, going clockwise, I pick the last 3 wires of the loops (S) to be neutral and the first 3 wires (I) from the loops to be the AC wires

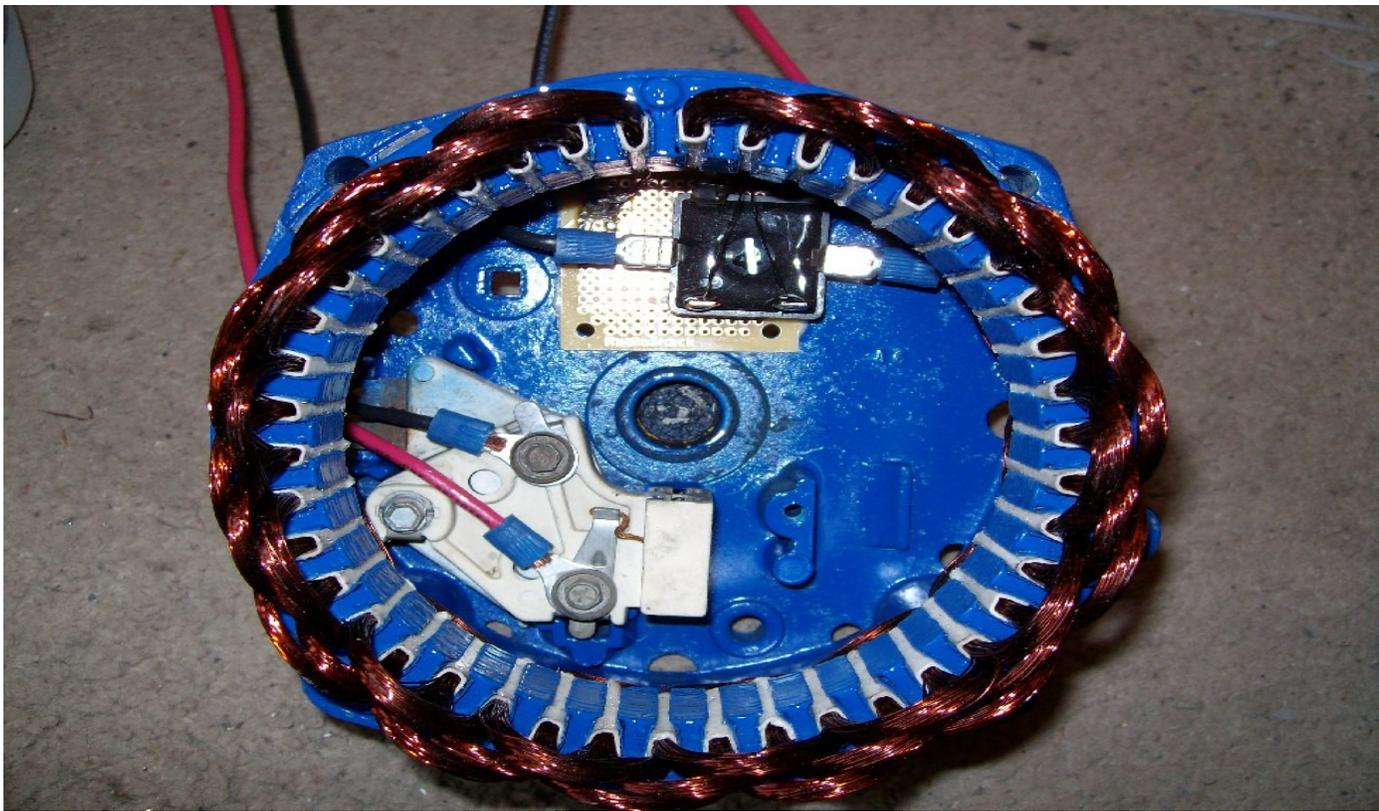
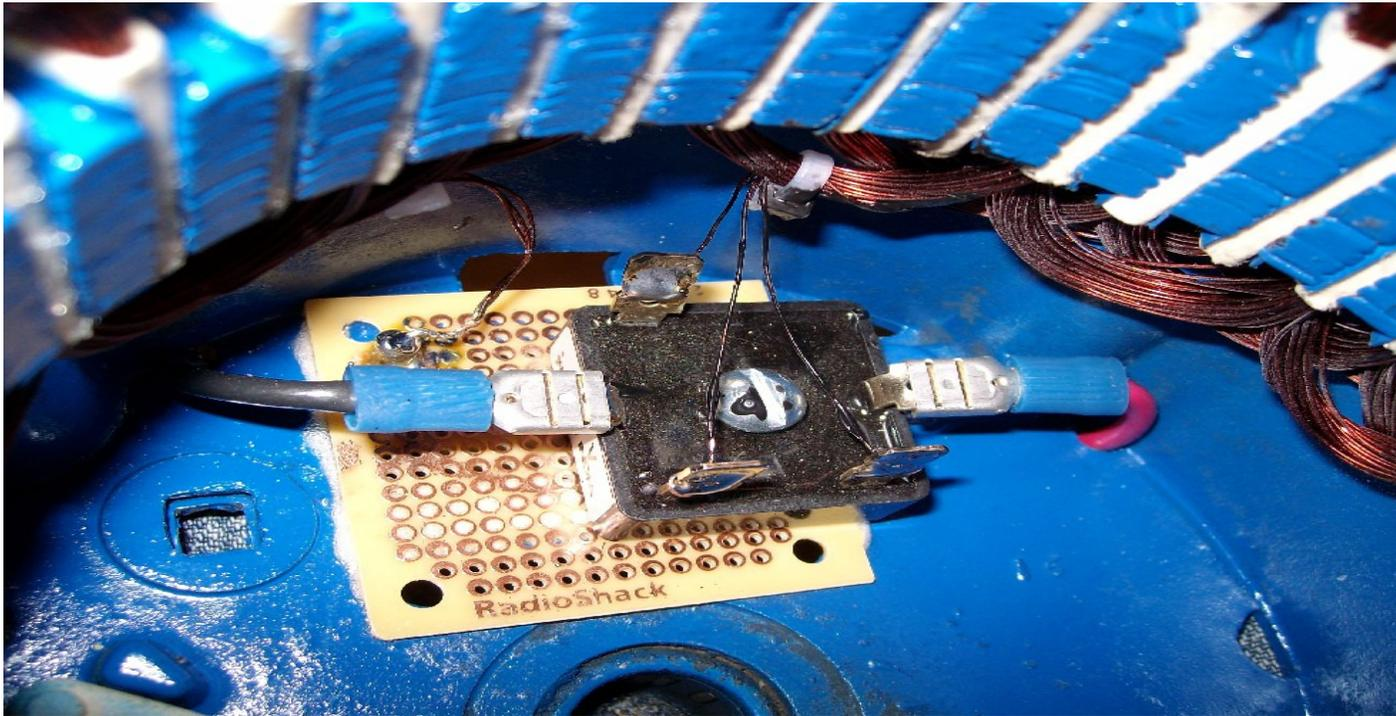

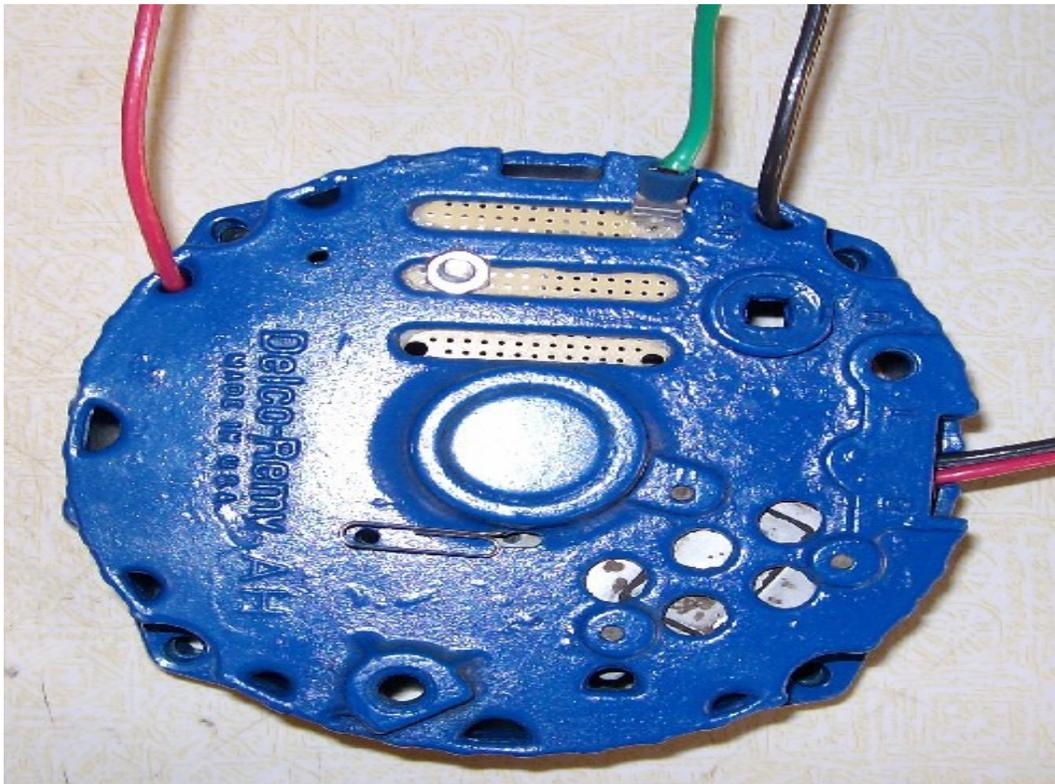

12th : You're 99% finished! Now you should have the coil rewind, the brush housing wired up, and the bridge rectifier in place and soldered to the stator wires. Put a little axel grease in the bearing area to make sure it works for years and slap it all back together and put the bolts in. Pull the paperclip out and spin the stator. Your alternator should be reassembled and ready for installation on your vehicle or on your bench top model. Stan Meyer would be proud of you.

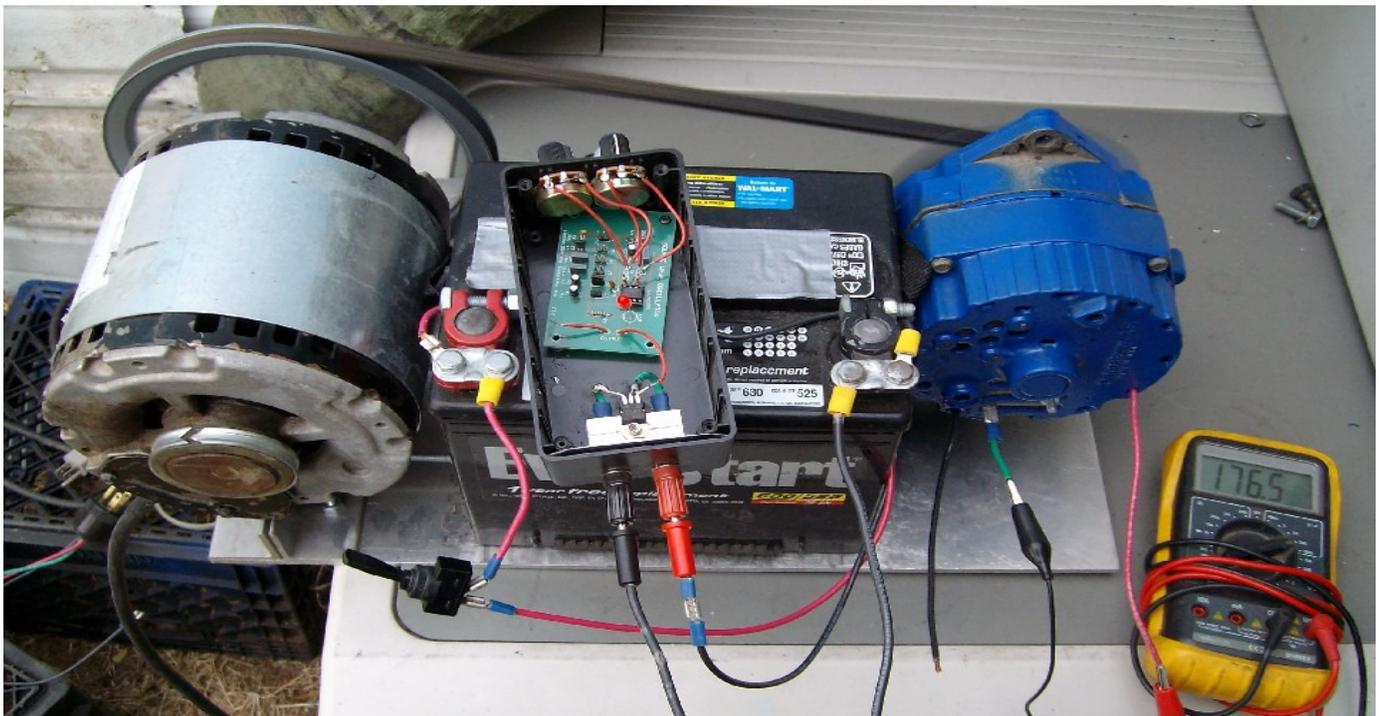

13th : Connect your electronics to your alternator. Make your LRC circuit and start testing. Below are two circuits of Meyer's that I've enhanced showing the techniques stated in his patents and book you can find on CD/DVD in the Video folder sold from WWW.WaterforFuel.Com .

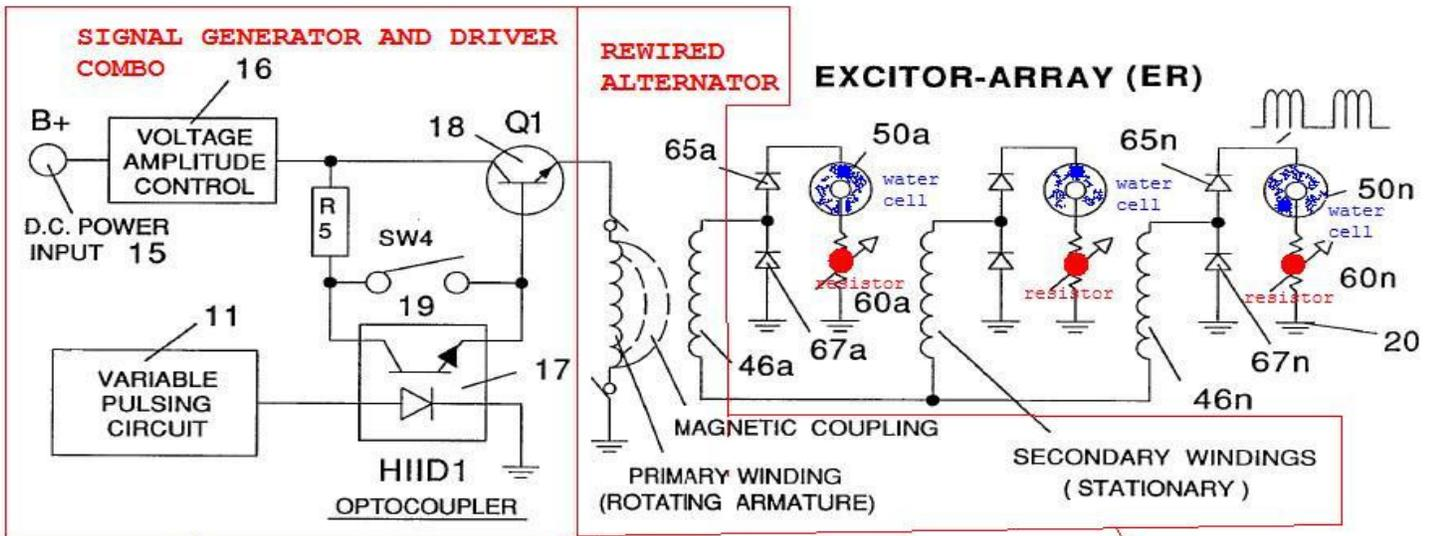

PULSE VOLTAGE FREQUENCY GENERATOR

FIGURE 5

Finished and for sale

Finished and for sale

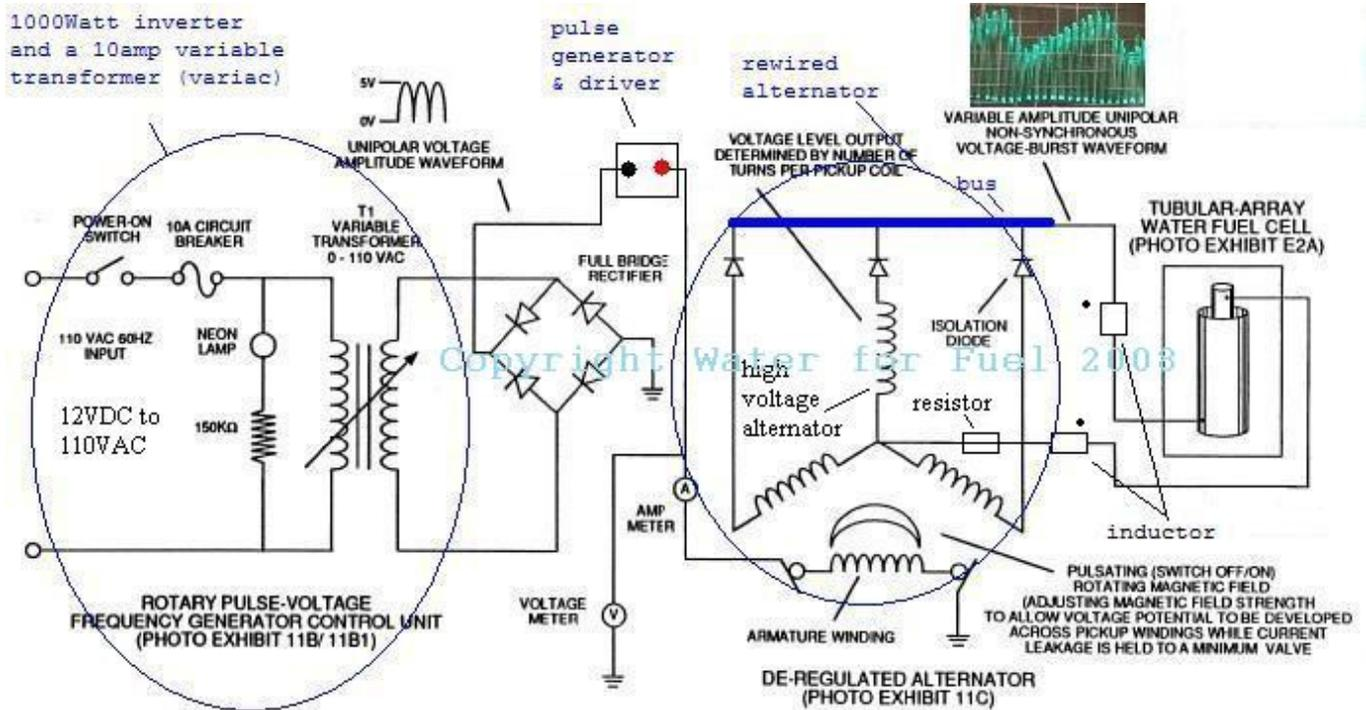

14th : Below is the LRC circuit I'm currently using. It consist of 4 microwave capacitors (stolen from broken microwaves at the garbage dump, .80uF -1uF 1800VAC and above)), 1 dual wound 3.3mh inductor (part number 871-B82734R2462B30 from WWW.Mouser.Com), and 1 resistor (part # 271-120 from Radio Shack, 8 Ohm 20WATT Non-Inductive). Then I connect my water cell to the capacitor bank.

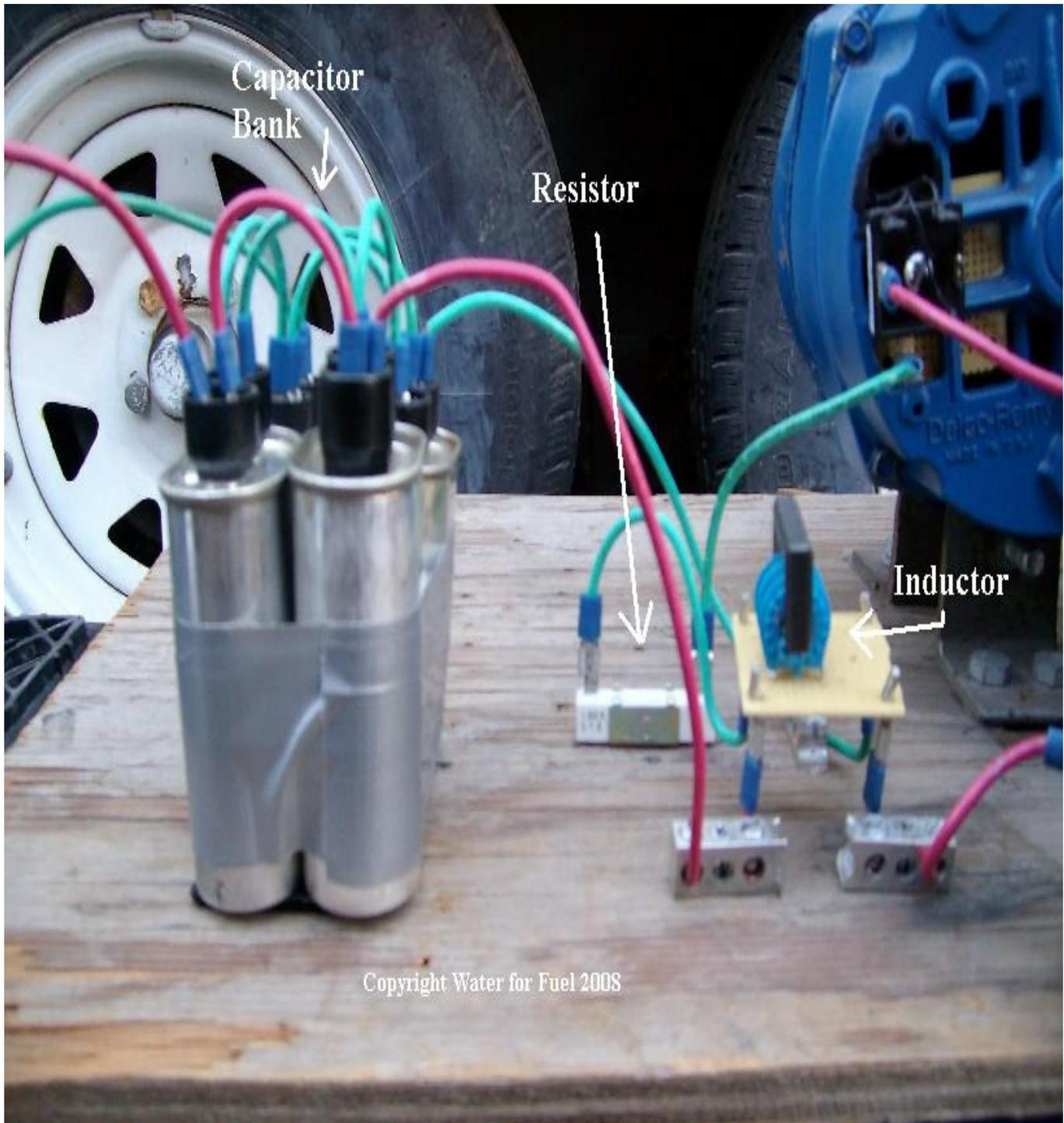

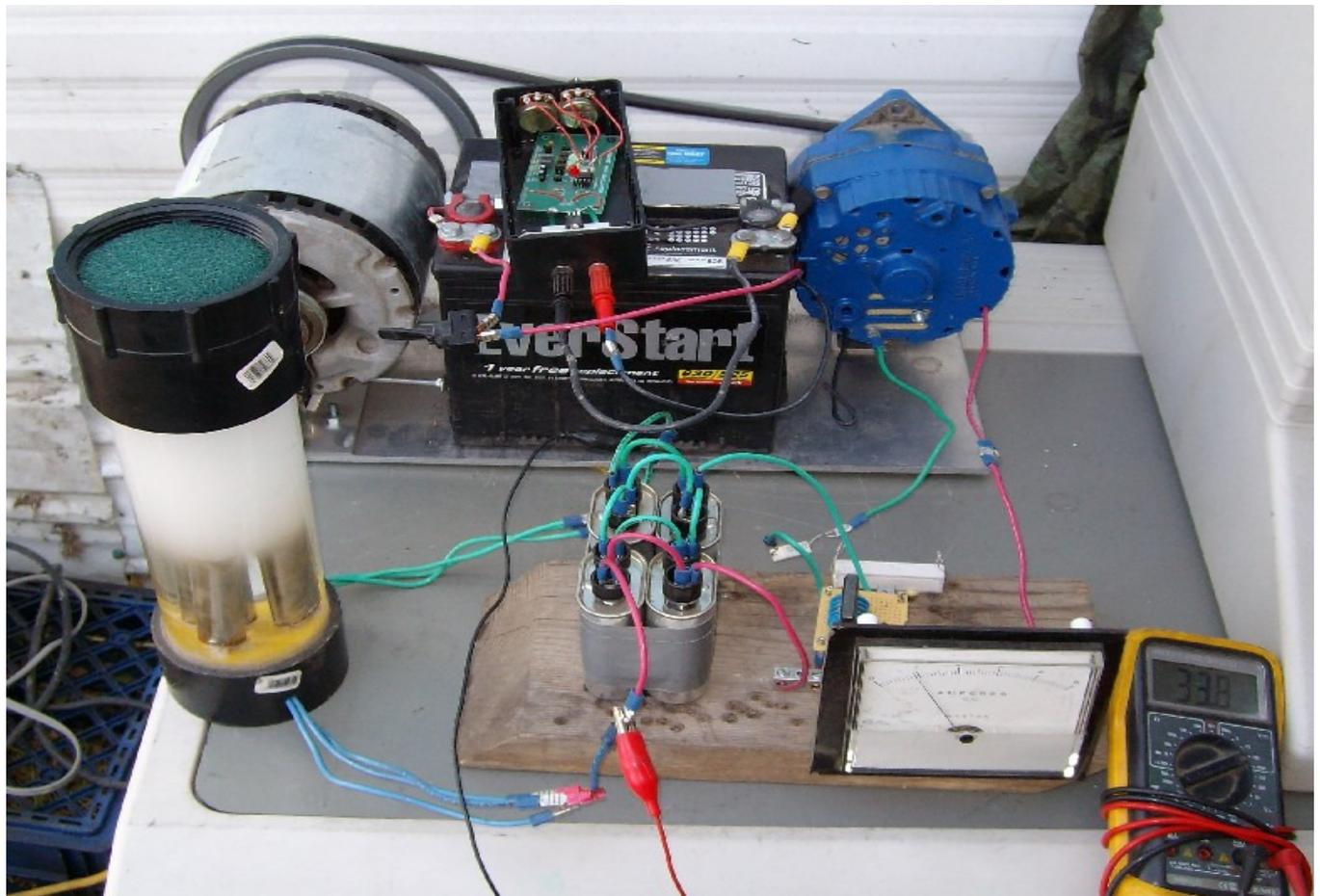
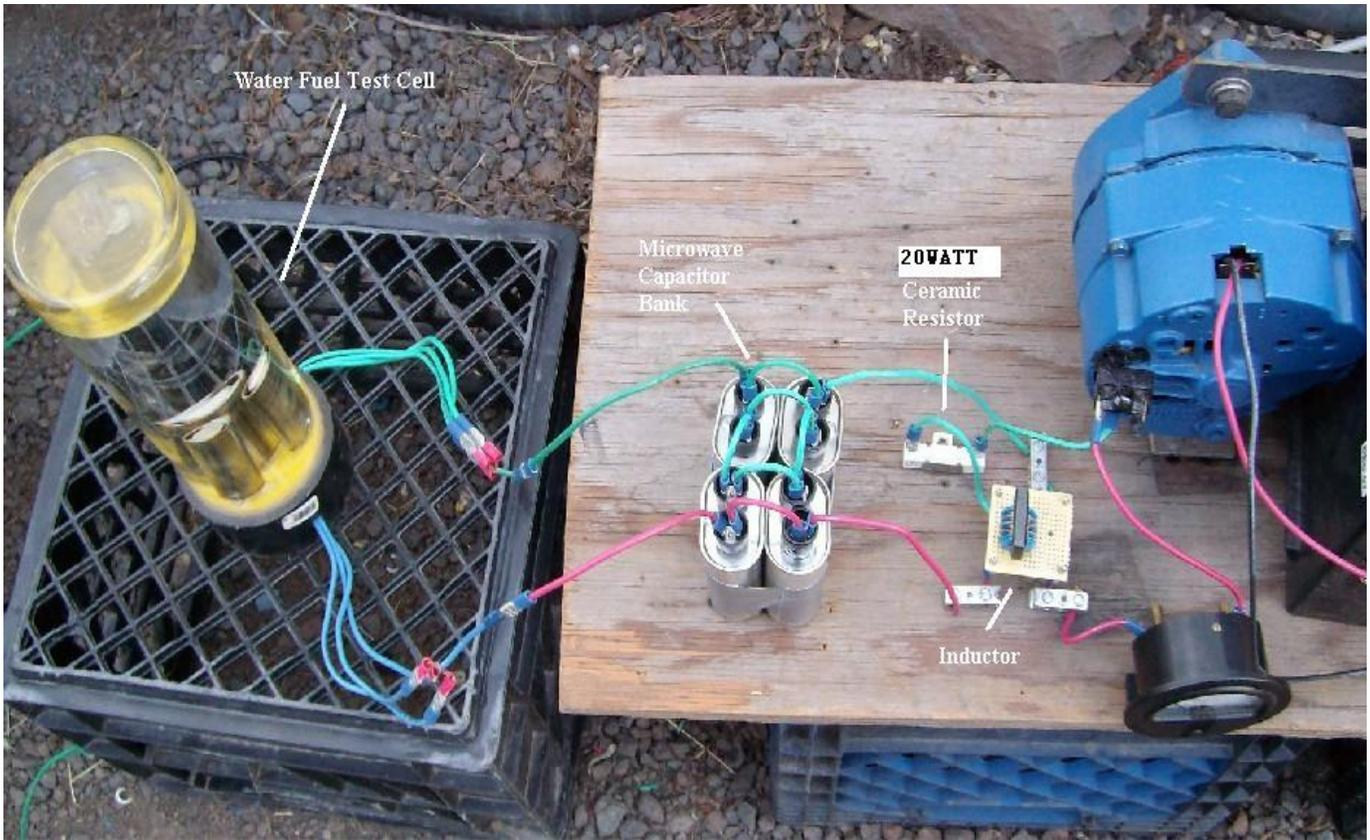

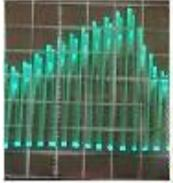

from
high voltage
alternator
Positive



4 microwave
capacitors
with 10Mohm
resistance

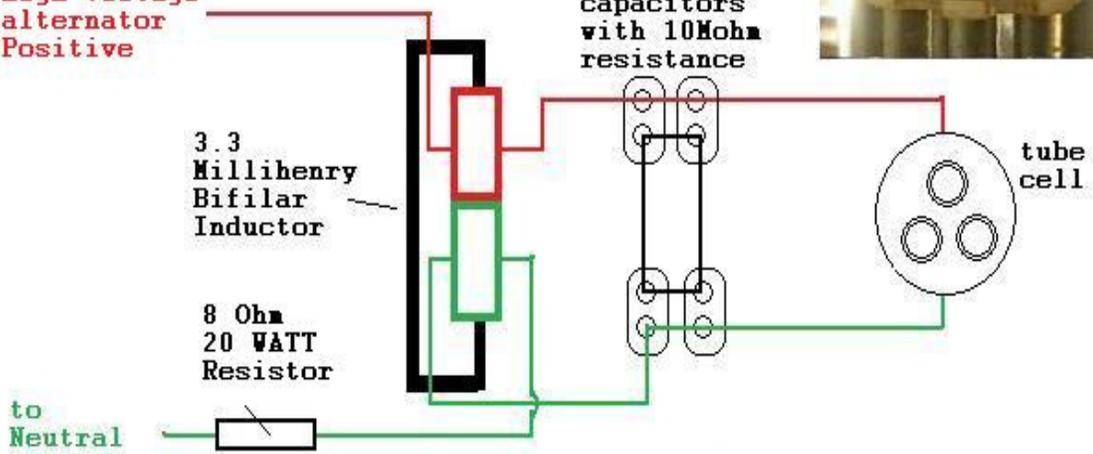

Copywrite 2008 Water for Fuel

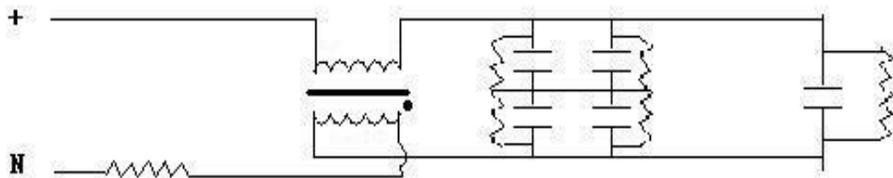

Pulse Generator and Driver Installation

The Pulse Generator is a simple square wave oscillator in a kit form (part number CPS K111 from WWW.Electronics123.Com) and the driver is a power mosfet (part number STP16NK60Z from WWW.Mouser.Com). The kit has been hacked by adding a 100K potentiometer to R1 and R2. R2 is replaced with a 1K resistor. The rest is up to you (box, connections, power plug, heat sink, pots, solder, and time). Or you can get the working version from WWW.WaterforFuel.Com .

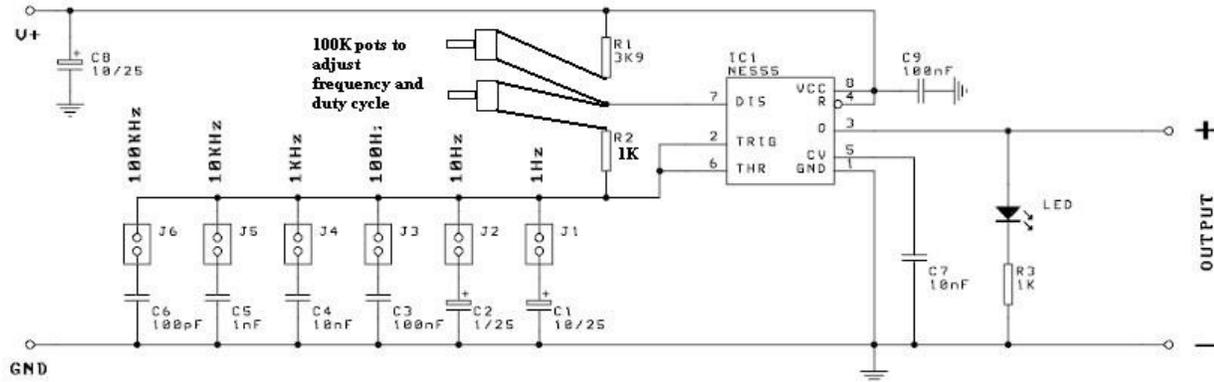

Copyright Water for Fuel

Hacked by Epicdude for WWW.WaterforFuel.Com

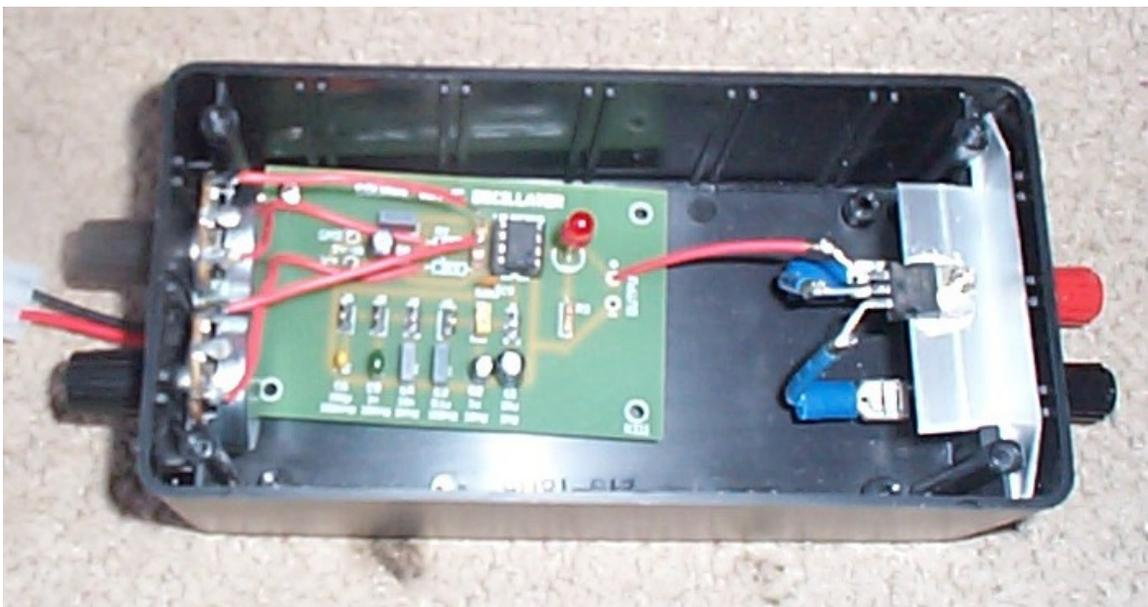

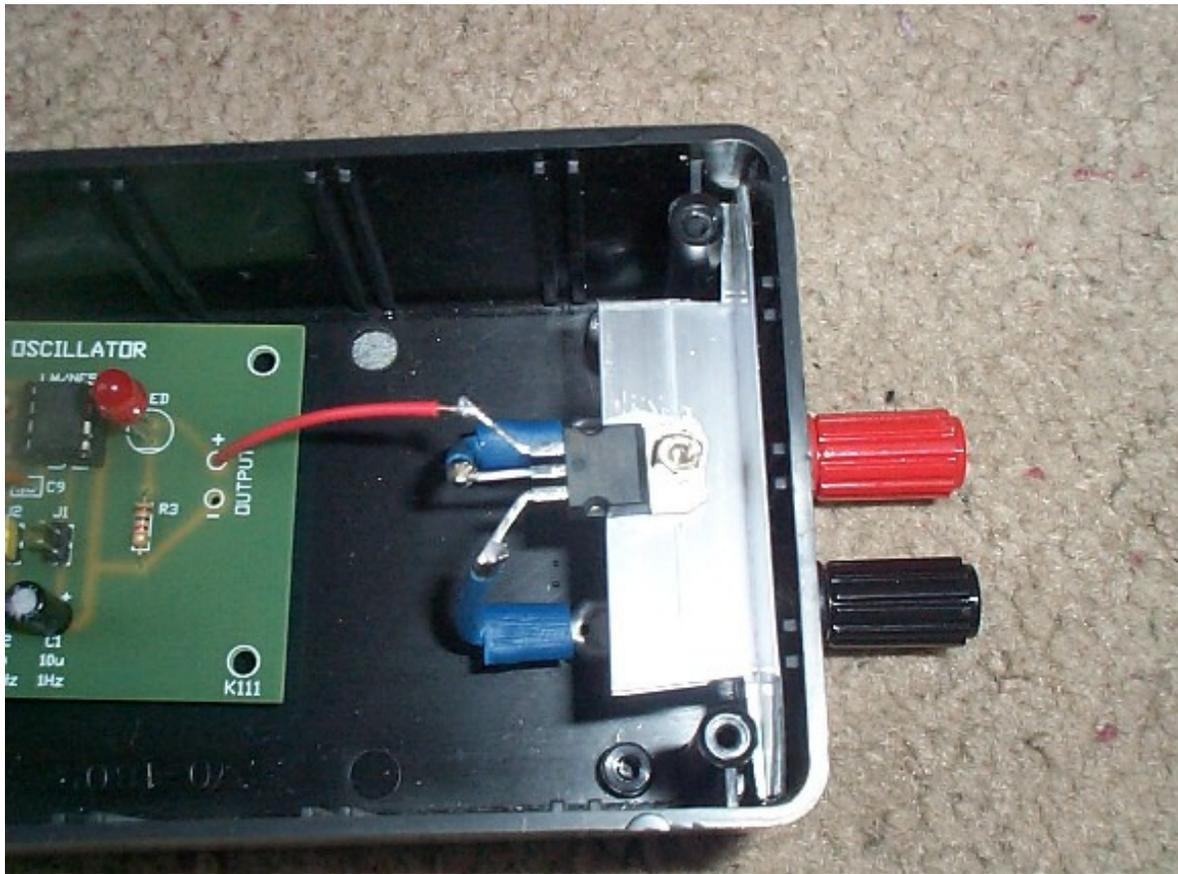

If you've tested everything and it all works (light is blinking) then you are ready to connect the pulse generator to the alternator. I use the negative wire to pulse ON/OFF leaving the positive wire always connected. I use 2 mini toggle switches under my dash, the 1st toggle is for the electronics to be turned on and off, and the 2nd for the main positive power to be turned on and off through a 30 amp relay to the alternator. I always turn the main positive power off before turning the vehicle off or the electronics off.

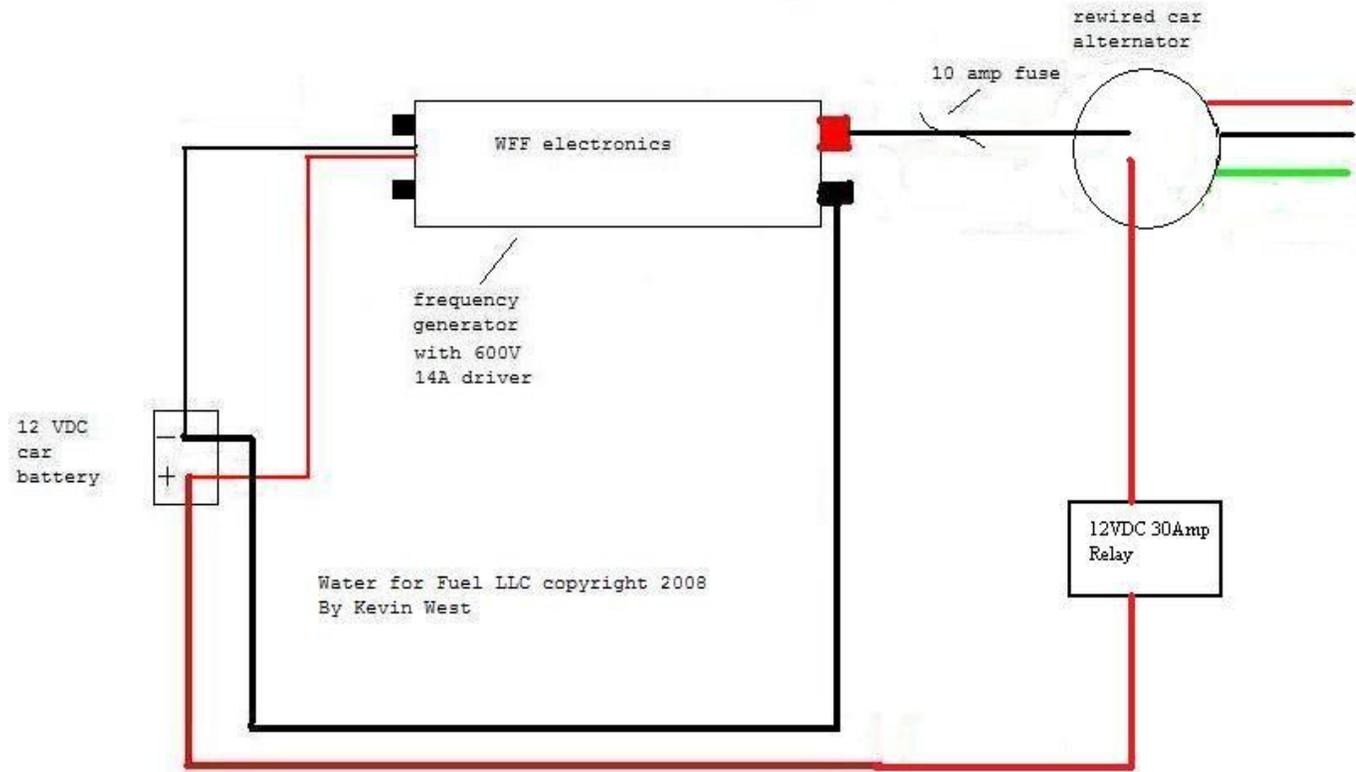

Now connect your red positive wire to your alternator via the 30 amp relay. Connect your negative wire to your **IN** (black) post on your electronics (use a 5 to 10 amp fuse in this segment). Connect your alternator black wire to the **OUT** (red) post on the electronics. Connect the electronics' small red power wire to positive 12VDC. Connect the electronics' small black negative wire to your remote switch located inside your vehicle. Connect your remote switch to any ground (negative) near the switch. When you turn ON the remote switch your red LED should turn on inside your electronics box. Set your electronics to 20 Hz, and tune up or down for best performance. You should NOT run your electronics without the alternator spinning though.

Note: If you got this document and didn't get the full CD or DVD, and you feel as if you're not seeing the whole picture, well you're not. You need to visit WWW.WaterforFuel.Com and buy the CD or DVD so you know what I was looking at when I wrote this (and to get the most current version of this document). The info I provide is extensive, but this document wasn't meant to cover it all, only the basics. There are lots of videos, patents, books that should be read, and much more detailed schematics of the electronics Stan Meyer used on the CD/DVD.

Keep up to date by visiting WWW.WaterforFuel.Com for the latest info and by subscribing to my blog.

Here are pictures of the wave forms I'm getting out of the rewired alternator by pulsing it ON/OFF. I call this a Tidal Wave.

Tidal Wave with no inductors.

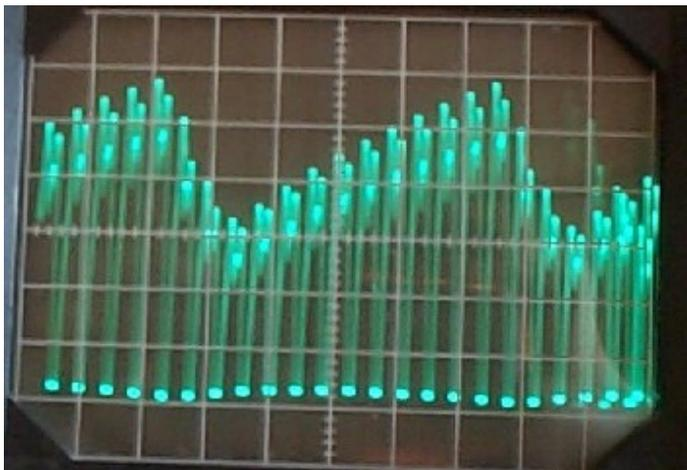

Tidal Wave with inductors before and after.

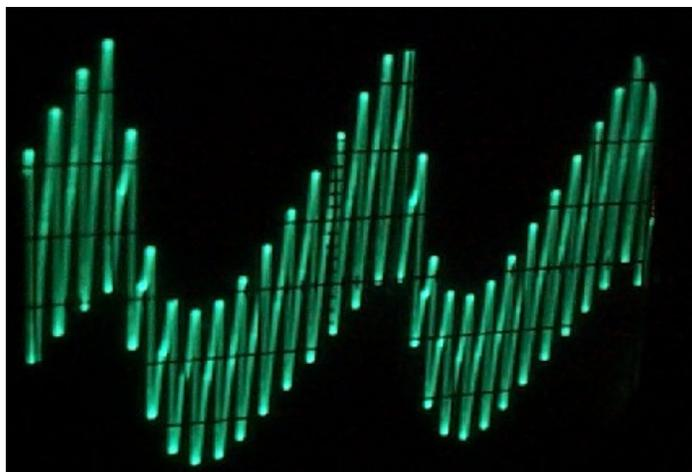

Remember you are pulsing the alternator with less than 10 amps from the battery and to always use a fuse with your electronics. The driver mosfet will handle 14 amps and 600 volts MAX, but only works with 12 volts. So if you blow the 10 amp fuse constantly you may have a short. If you're using a lot of amps/volts in test though feel free to replace it with a 15 amp fuse, but it could burn up your Mosfet. If you dink around and ONLY use the electronics to pulse into your electrolysis cell you will burn them up for sure. I put a heavy voltage mosfet in the driver so it would stay cool, not so you could run 14 amps though it for a few minutes (you will burn it up). If you want to do that please replace the Mosfet with something bigger like a 100amp Mosfet.

INFO ABOUT TUBE CELLS

Stan was very clear in his patent diagram of cell production rates (located in the Video folder on the CD/DVD).

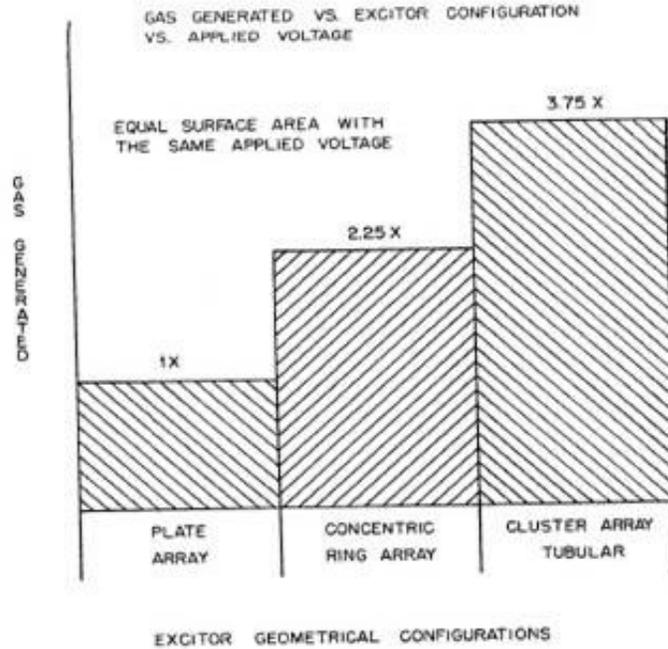

I read of Stan using a plate cell configuration in 1 or 2 patents, that was it, the rest were all tube cells and the final design is an injector which is basically a tube cell as well. There will be no need for a tank or tube cells when the injector is finalized.

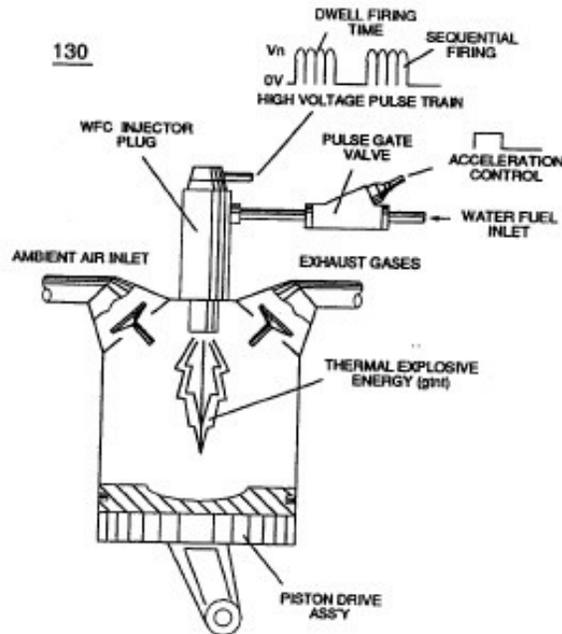

FIGURE 4-11: INTERNAL COMBUSTION ENGINE RETROFIT

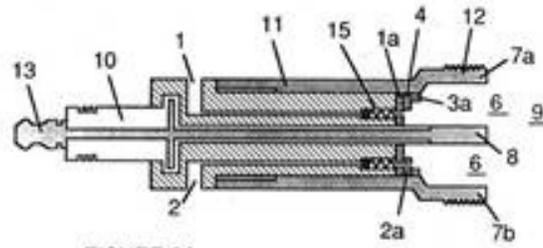

FIGURE 2A

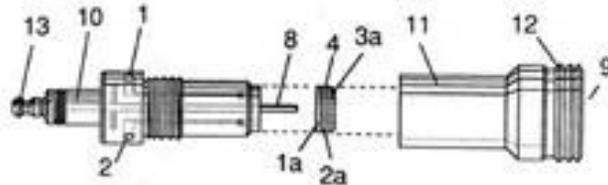

FIGURE 2C



In Stan's book he says to use two 3 inch tubes, one inside the other, the inner being .5 and the outer being .75 inches. Stan's brother uses 3 tubes (.5, .75, and 1.0), one inside the other. I got my SS 304 tube from WWW.SpeedyMetals.Com. I use .5 and .75 tube with .035 wall thickness. I use .080 weed eater line to separate the tubes. I use some GE II Indoor/Outdoor Silicone (clear caulk) to push between the two (or three) tubes at both ends. Let them dry over night and remove the weed eater line. I drill and tap screw holes in the side of the tubes so I can attach my stainless steel wire to each (in series). I found my stainless steel wire in a broken space heater. You know the heater coils? Stainless Steel y0!! Make 1 tube 1/2 inch longer than the other so you can attach the wire without any short circuits.



The other method is to use plastic or nylon spacers. I had a machinist make me a custom punch to cut some spacers out of nylon washers. Check out WWW.WaterforFuel.Com for more details and possible purchasing.



Stan also talks of Delrin (page 12&81 in WFC422DA) that is coating the outside of the outer tube. This is supposed to restrict amp leakage. The coating is #72 on the picture below. I'm testing plastic tubing which is the same theory.

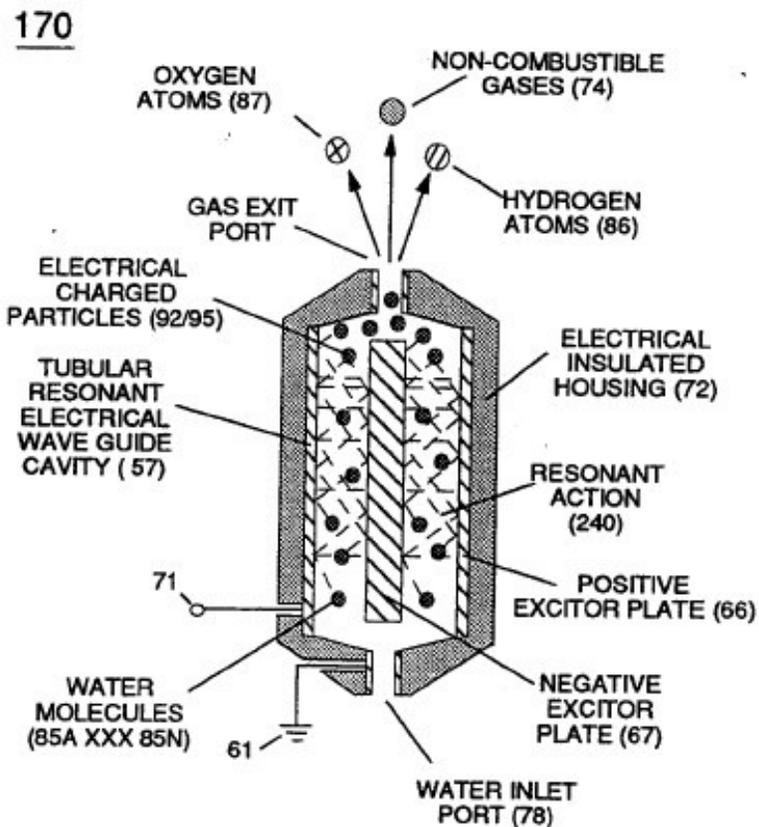

FIGURE 3-25: RESONANT CAVITY

Below is a picture of the Dodge with the big tank in front. This is not the normal size of the electrolysis tank you will need. Yours will be much smaller, possibly even the injectors only. This vehicle is strictly for the Media Circus and The Lap Around America I am sponsoring for water powered vehicles ONLY. When I stop to do demonstrations I want to hook up a gas bar-b-q grill, an on-demand hot water heater, a welding torch, and a propane generator up to the Dodge's cell/tank to show that HHO gas has an every day use and is safe to use as well. See my videos at WWW.YouTube.Com/WaterforFuel .

Let me know if I missed something in this DIY by emailing the guy below.

Kevin@WaterforFuel.Com



The ionizers on the intake of the Dodge are to raise the yield of the HHO gas from 2.5 times the power of gasoline up to 8 times the power or more. The BTUs from the HHO gas exploding travel into the water mist/humidity in the air inside the cylinder during explosion (not to the cylinder walls). This stops over heating and adds power. This essentially is a steam engine. And nothing is going to rust any more than average because the engine's normal running temperature is over the boiling temperature of water. So any water that may accumulate will be turned into steam from the surrounding engine temperature. And oil blow by from the cylinders and the PCV valve will keep everything lubricated. I will use a propane carburetor to meter the HHO gas into my engine. You did know you can get a tank of Hydrogen, convert to a propane carburetor, meter it and drive down the road on the Hydrogen gas from the tank right? The HHO gas can be used the same way Propane is, except HHO is made on-demand.

And vote Kevin West for President in 2012!!! You can visit WWW.KEVINWESTFORPRESIDENT.COM and WWW.KEVINWEST2012.COM to see what I will do to make a real change for the better!